



GaAs pHEMT MMIC MEDIUM POWER AMPLIFIER, 24 - 35 GHz

Typical Applications

The HMC1131LC4 is ideal for:

- Point-to-Point Radios
- Point-to-Multi-Point Radios
- VSAT & SATCOM

Features

- High Saturated Output Power: 25 dBm @ 16% PAE
- High Output IP3: 35 dBm
- High Gain: 22 dB
- High P1dB Output Power: 24 dBm
- DC Supply: +5V @ 225 mA
- Compact 24 Lead 4x4 mm SMT Package: 16 mm²

Functional Diagram

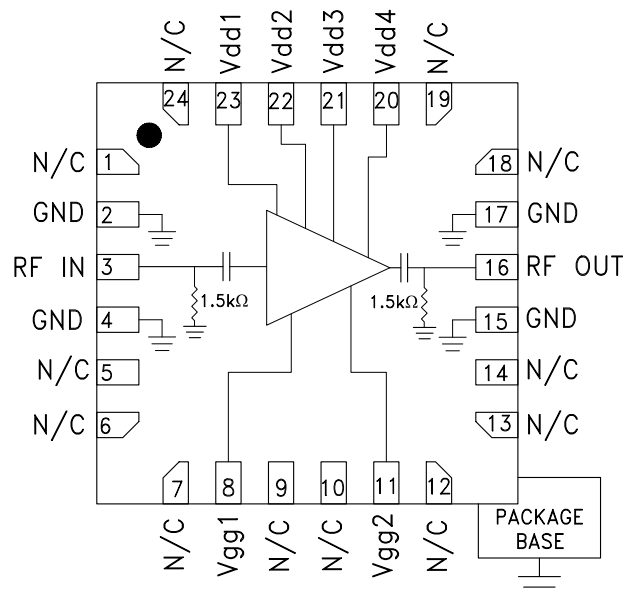

General Description

The HMC1131LC4 is a GaAs pHEMT MMIC driver amplifier which operates between 24 and 35 GHz. The amplifier provides 22 dB of gain, +35 dBm Output IP3, and +24 dBm of output power at 1 dB gain compression, while requiring 225 mA from a +5V supply. The HMC1131LC4 is capable of supplying +25 dBm of saturated output power with 16% PAE and is housed in a compact leadless 4x4 mm ceramic surface mount package. The HMC1131LC4 is an ideal driver amplifier for a wide range of applications including point-to-point radio from 24 to 35 GHz.

Electrical Specifications

$T_A = +25^\circ C$, $V_{dd1} = V_{dd2} = V_{dd3} = V_{dd4} = +5V$, $I_{dd} = +225 mA$ [1]

Parameter	Min	Typ.	Max	Min	Typ.	Max	Units
Frequency Range	24 - 27		27 - 35				GHz
Gain	22	24		20	22		dB
Gain Variation over temperature		0.031			0.022		dB/°C
Input Return Loss		8			8		dB
Output Return Loss		7			7		dB
Output Power for 1 dB Compression (P1dB)	22	24			24		dBm
Saturated Output Power (P _{sat})		27			25		dBm
Output Third Order Intercept (IP3) [2]		34			35		dBm
Supply Current (I _{dd})		225			225		mA

[1] Adjust V_{gg1} and V_{gg2} between -2 to 0V to achieve I_{dd} = 225mA typical

[2] Measurement taken at P_{out} / tone = +10dBm

GaAs pHEMT MMIC MEDIUM POWER AMPLIFIER, 24 - 35 GHz

Broadband Gain & Return Loss

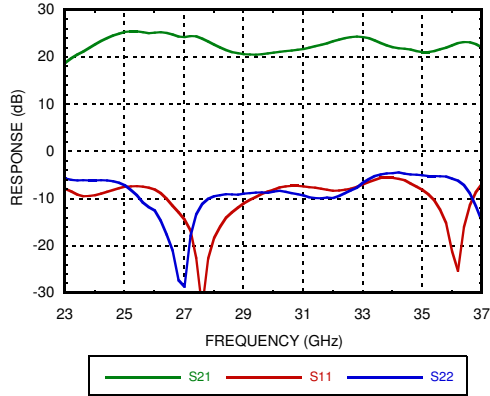

Gain vs. Temperature

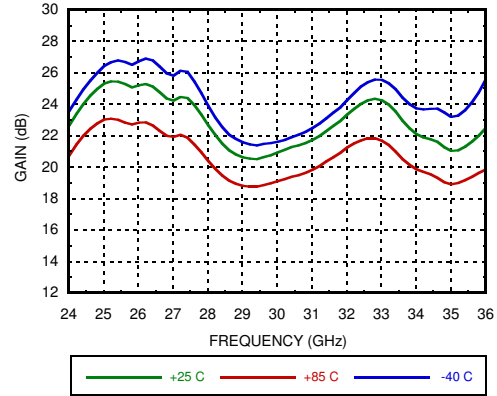

Input Return Loss vs. Temperature

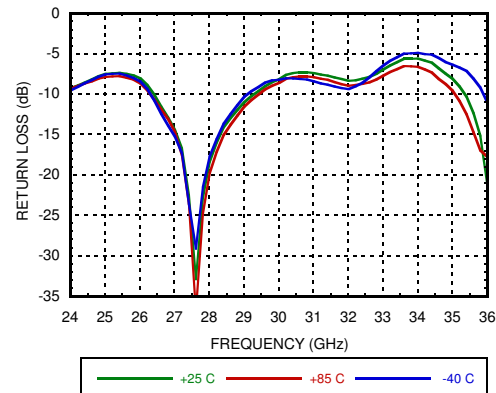

Output Return Loss vs. Temperature

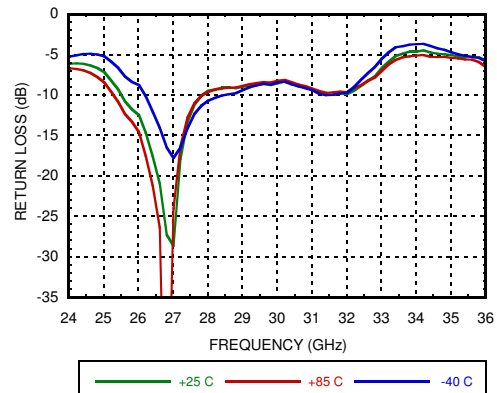

P1dB vs. Temperature

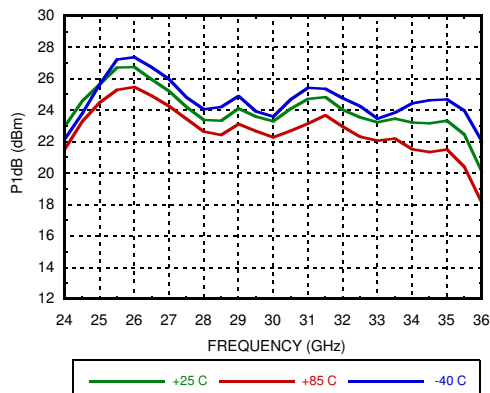

P1dB vs. Supply Voltage

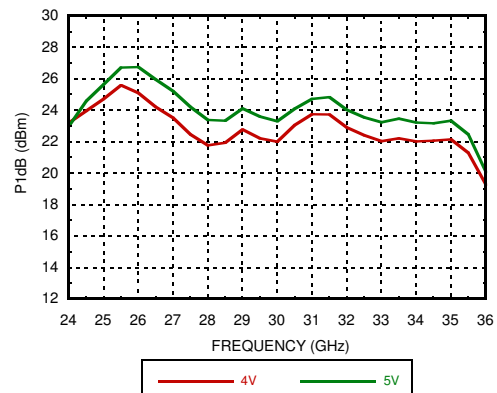



**GaAs pHEMT MMIC MEDIUM
POWER AMPLIFIER, 24 - 35 GHz**

AMPLIFIERS - LINEAR & POWER - SMT

Psat vs. Temperature

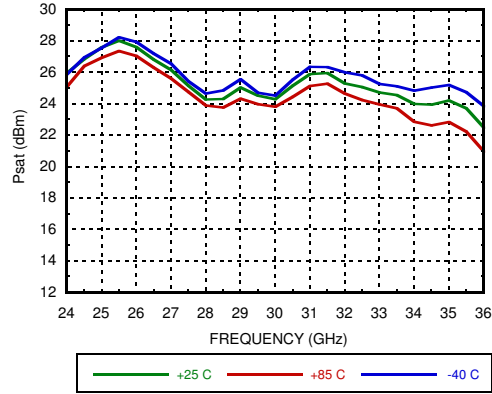

Psat vs. Supply Voltage

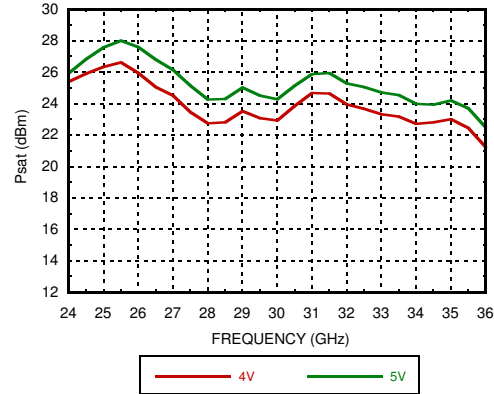

P1dB vs. Supply Current

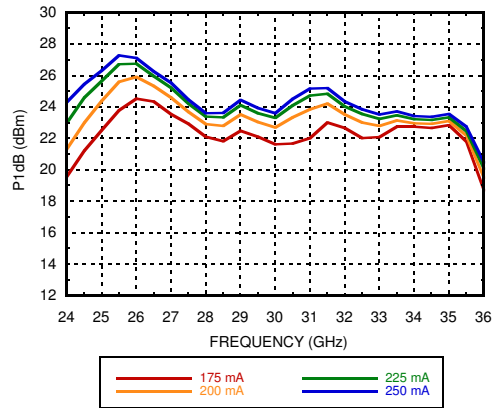

Psat vs. Supply Current

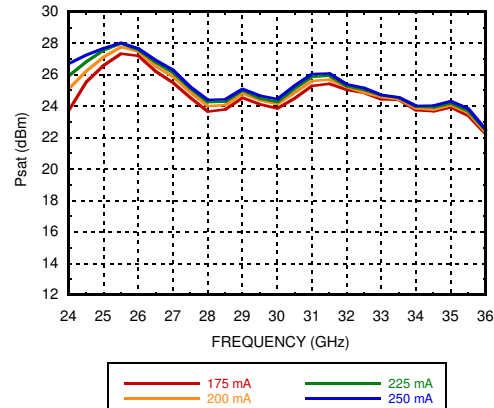

Output IP3 vs. Temperature [1]

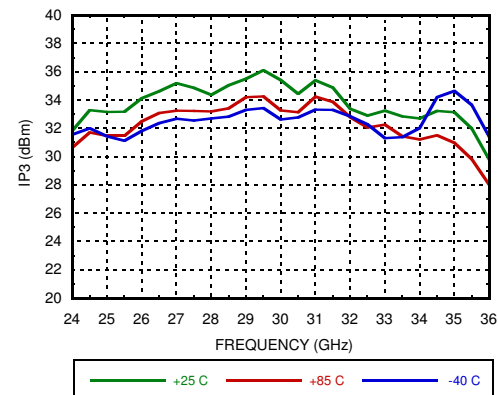

Output IP3 vs. Supply Current [1]

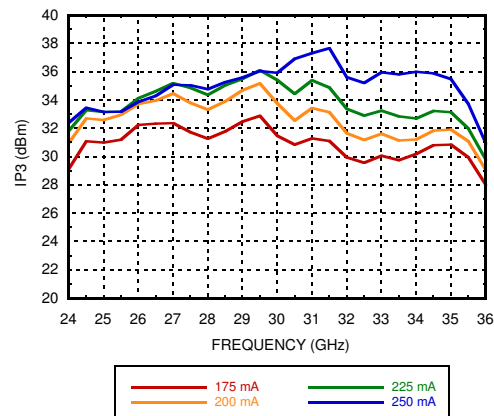

[1] Pout/Tone = +10 dBm



**GaAs pHEMT MMIC MEDIUM
POWER AMPLIFIER, 24 - 35 GHz**

Output IP3 vs. Supply Voltage [1]

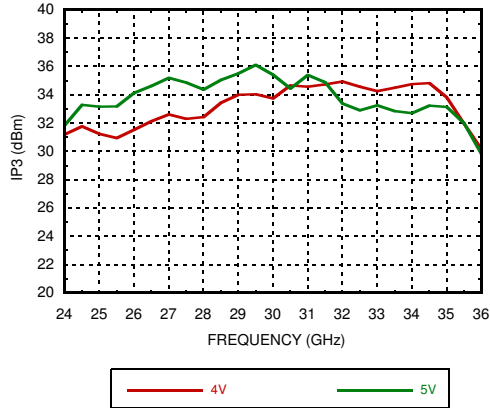

Output IM3 @ Vdd = +4V

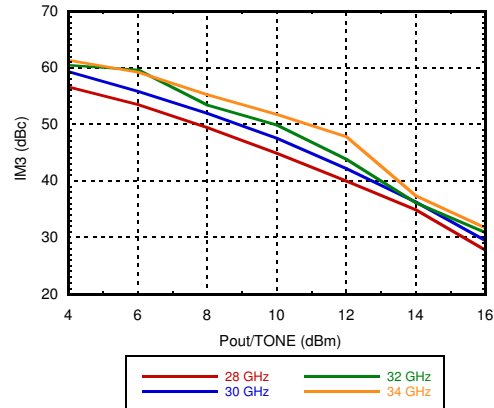

Output IM3 @ Vdd = +5V

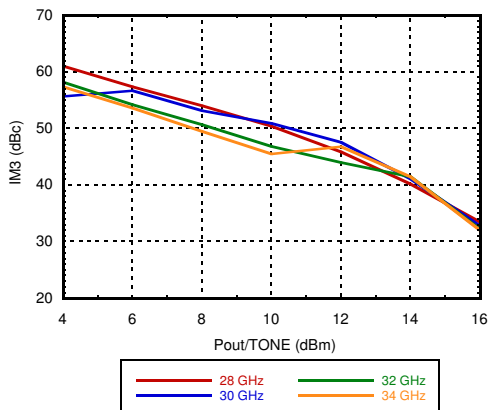

Power Compression @ 30.5 GHz

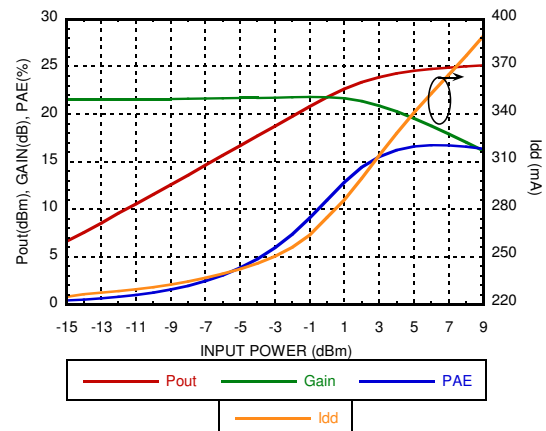

**Gain & Power vs. Supply Current
@ 30.5 GHz**

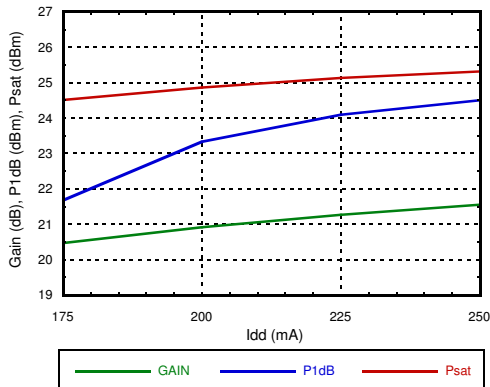

**Gain & Power vs. Supply Voltage
@ 30.5 GHz**

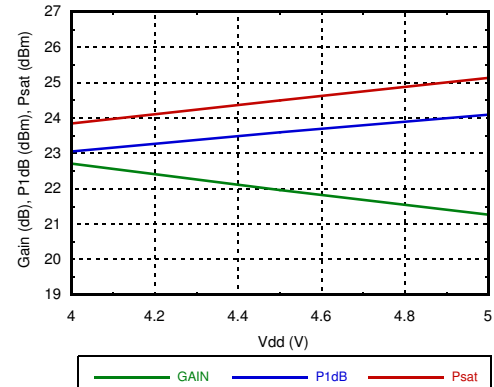

[1] Pout/Tone = +10 dBm



GaAs pHEMT MMIC MEDIUM POWER AMPLIFIER, 24 - 35 GHz

Reverse Isolation vs. Temperature

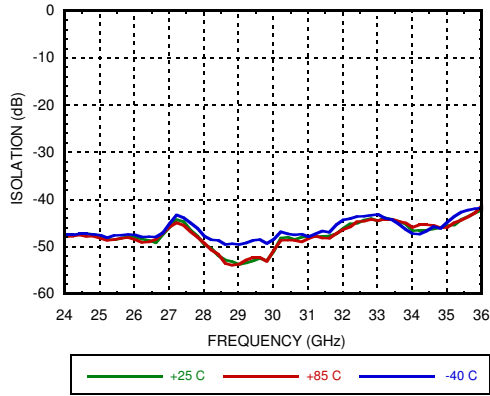

Power Dissipation @ 85C

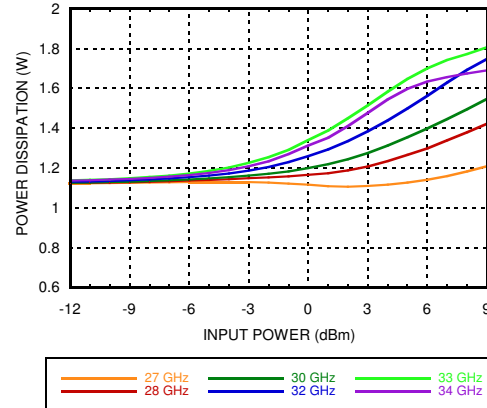

Input IP3 vs Idd over Pout/tone @ 30 GHz [1]

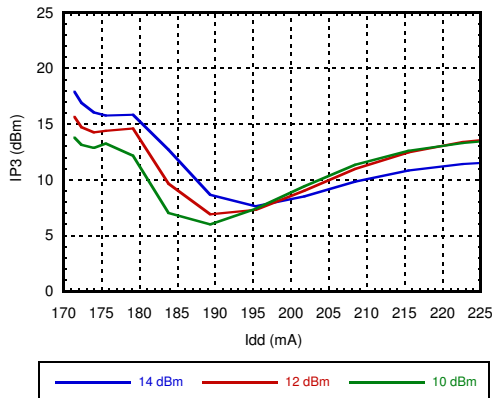

Output IP3 vs Idd over Pout/tone @ 30 GHz [1]

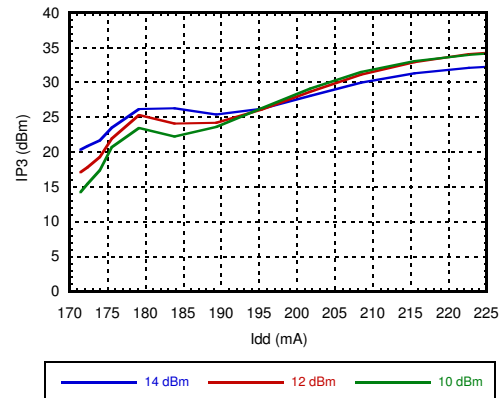

Gain vs Idd over Pout/tone = 14 dBm @ 30 GHz [1]

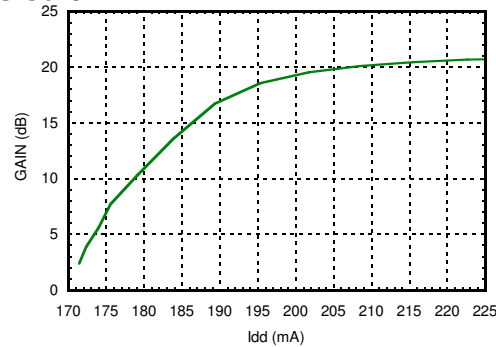

[1] Vdd = 5V, Idd2 fixed = 170mA, Idd1 varied 0 to 50 mA

**GaAs pHEMT MMIC MEDIUM
POWER AMPLIFIER, 24 - 35 GHz**
Absolute Maximum Ratings

Drain Bias Voltage (Vdd)	5.5V
RF Input Power (RFIN)	+12 dBm
Channel Temperature	175 °C
Continuous Pdiss (T=85 °C) (derate 22mW/°C)	1.97W
Thermal Resistance (R _{TH}) (junction to ground paddle)	45.5°C/W
Operating Temperature	-40 °C to +85 °C
Storage Temperature	-65 °C to 150 °C
ESD Sensitivity (HBM)	Class 0, Passed 150V

Typical Supply Current vs. Vdd

Vdd (V)	Idd (mA)
+4	225
+5	225

Adjust Vgg1 to achieve Idd = 225 mA

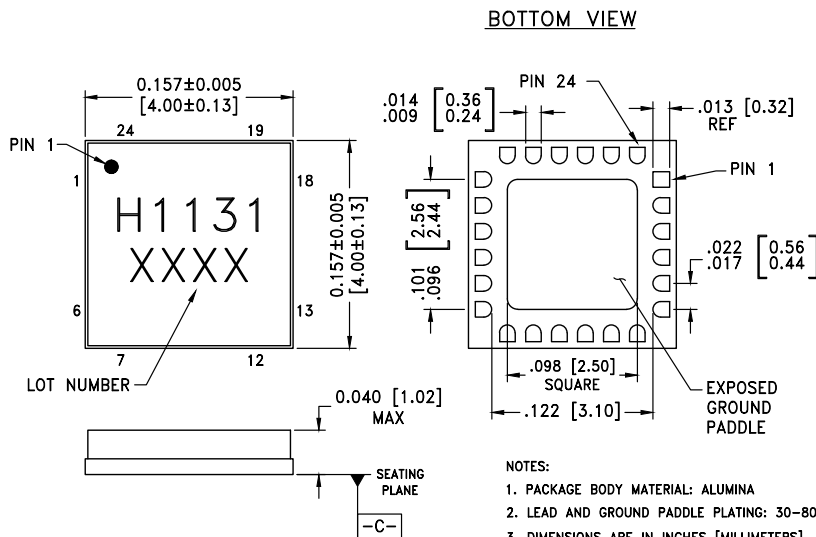
**ELECTROSTATIC SENSITIVE DEVICE
OBSERVE HANDLING PRECAUTIONS**
Outline Drawing

Package Information

Part Number	Package Body Material	Lead Finish	MSL Rating ^[2]	Package Marking ^[1]
HMC1131LC4	Alumina White	Gold over Nickel	MSL3 ^[2]	H1131 XXXX



[1] 4-Digit lot number XXXX

[2] Max peak reflow temperature of 260 °C

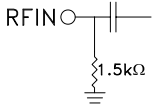

GaAs pHEMT MMIC MEDIUM POWER AMPLIFIER, 24 - 35 GHz

Pin Descriptions

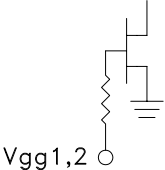
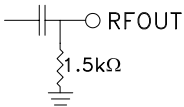
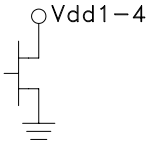
Pin Number	Function	Description	Pin Schematic
1, 5, 6, 7, 9, 10, 12, 13, 14, 18, 19, 24	N/C	These pins are not connected internally, however all data shown herein was measured with these pins connected to RF/DC ground externally.	
3	RF IN	This pin is DC coupled and matched to 50 Ohms.	
2, 4, 15, 17	GND	These pins and package bottom must be connected to RF/DC ground.	
8, 11	Vgg1, Vgg2	Gate control for amplifier. External bypass capacitors of 100 pF, 10 nF and 4.7 uF are required.	
16	RF OUT	This pin is DC coupled and matched to 50 Ohms.	
20, 21, 22, 23	Vdd1, Vdd2, Vdd3, Vdd4	Drain bias voltage for amplifier. External bypass capacitors of 100 pF, 10 nF and 4.7 uF are required.	

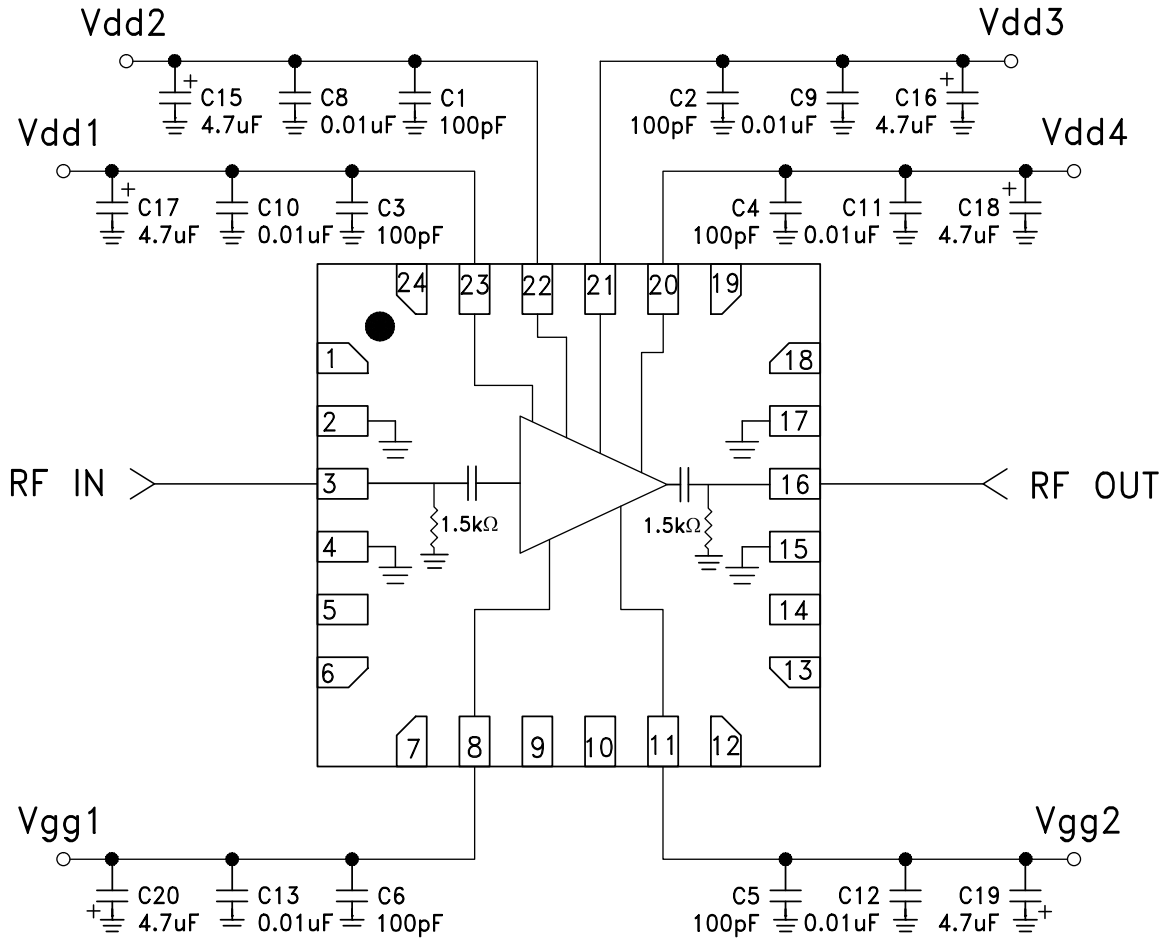
Application Circuit

Evaluation PCB

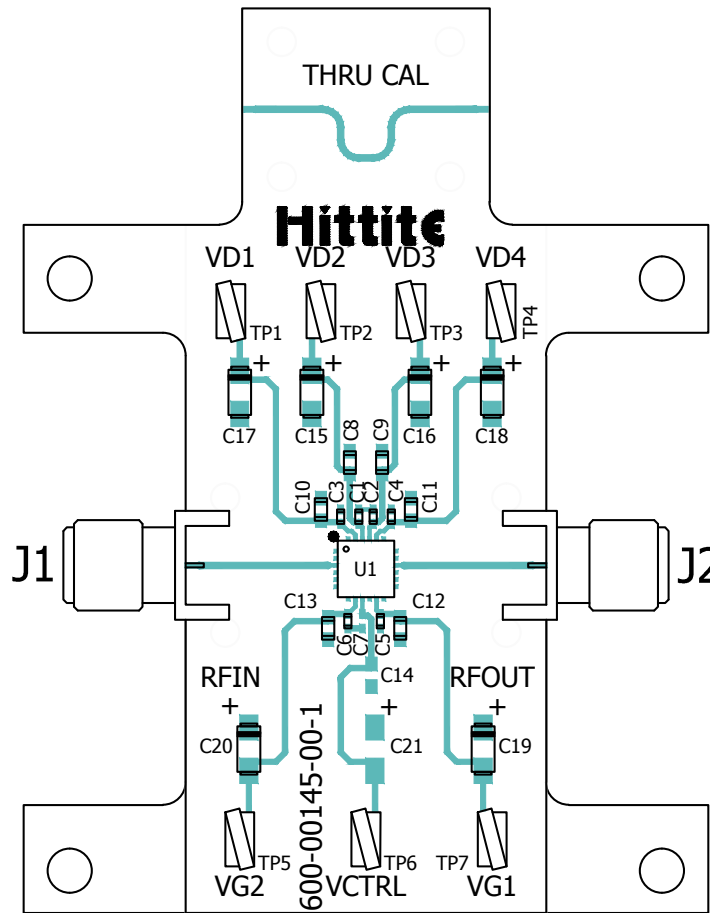

List of Materials for Evaluation PCB EV1HMC1131LC4 [1]

Item	Description
J1, J2	PCB Mount K Connectors
TP1 - TP7	DC Pin
C1 - C6	100 pF Capacitor, 0402 Pkg.
C8 - C13	10000 pF Capacitor, 0402 Pkg
C15 - C20	2.2 uF Capacitor, 0402 Pkg.
U1	HMC1131LC4
PCB [2]	600-00145-00 Evaluation Board

[1] Reference this number when ordering Complete Evaluation PCB

[2] Circuit Board Material: Rogers 4350 or Arlon 25FR

The circuit board used in the application should use RF circuit design techniques. Signal lines should have 50 Ohm impedance while the package ground leads and exposed paddle should be connected directly to the ground plane similar to that shown. A sufficient number of via holes should be used to connect the top and bottom ground planes. The evaluation circuit board shown is available from ADI upon request.



**GaAs pHEMT MMIC MEDIUM
POWER AMPLIFIER, 24 - 35 GHz**

Notes: